

## CTS40系列 交叉滚柱导轨手动位移台

CTS40 Cross-Roller Guide Manual Stages

CTS40-(X) CTSXY40-(X)  
CTSXY40-(X)B CTSXYZ40-(X)



CTS40系列交叉滚柱导轨手动位移台

| Model       | CTS40-(X) | CTSXY40-(X) | CTSXY40-(X)B | CTSXYZ40-(X) |
|-------------|-----------|-------------|--------------|--------------|
| 行程(mm)      |           | ±6.5        |              | XY:±6.5;Z:10 |
| 水平负载(kg)    | 3         | 3           | 1            | 2            |
| 灵敏度(μm)     |           | 2           |              |              |
| 平行度(μm)     |           | 5           |              |              |
| 直线度(μm)     |           | 3           |              |              |
| 微分头最小读数(mm) |           | 0.01        |              |              |
| 位移方向        | X轴        | XY轴         |              | XYZ轴         |



- 采用交叉滚柱导轨,可实现高精度、平滑的移动
- 主体材料为铝合金,质量轻,适合内置于其他装置

## 产品简介 OVERVIEW

CTS40系列是菲克科技开发的超高精密手动位移台,台面尺寸40×40mm。该系列产品主体材料采用铝合金,表面阳极氧化处理,强度较高、耐磨性好、外形美观。采用交叉滚柱导轨,精密微分头驱动,负载能力强,耐用性好。配合菲克科技精密加工工艺,使该系列产品具有不大于2μm的高灵敏度,并且运行平顺,无跳动现象。该系列产品主体材料为铝合金,质量轻,可内置于其他装置,适合对负载能力、运动精度等要求较高的情况下使用。

The CTS40 series is an ultra-high precision manual stage developed by Feinixs, table size 40\*40mm. The main material of this products is made of aluminum alloy, and the surface is anodized, which has high strength, good wear resistance and beautiful appearance. Use cross-roller guide, precision differentiator head drive, heavy load and good durability. With the precision processing technology of Feinixs, this series of products has a high sensitivity of not more than 2μm, and runs smoothly without jumping. The main material of this series of products is aluminum alloy, which is light in weight and can be built into other devices. It is suitable for use in situations with high requirements on load capacity and motion accuracy.

## 产品图纸 DIMENSIONS

### CTS40-C

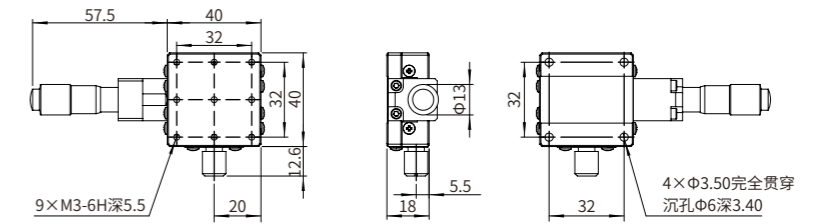
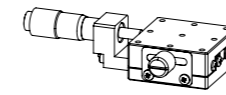

### CTS40-L

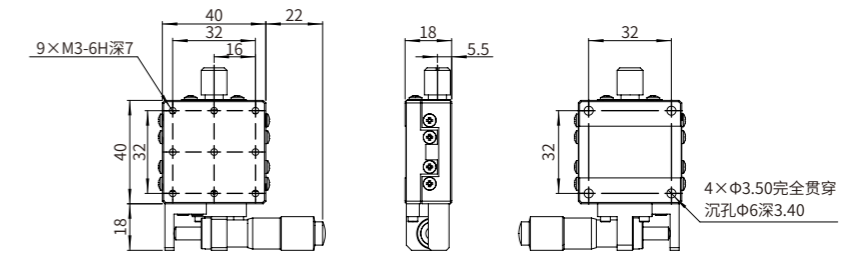
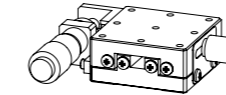

### CTS40-R

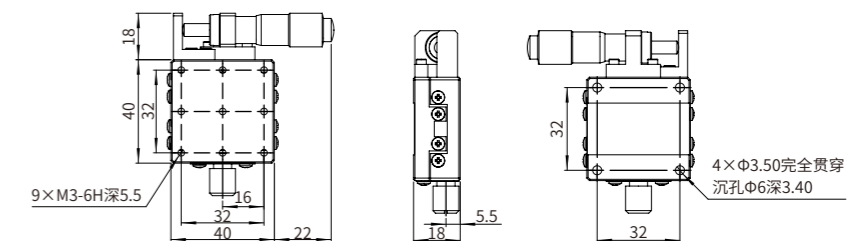
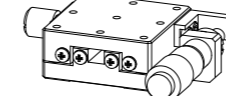

CTS40系列  
交叉滚柱导轨手动位移台

CTS40 Cross-Roller Guide Manual Stages

CTS40-(X) CTSXY40-(X)  
CTSXY40-(X)B CTSXYZ40-(X)



产品图纸 DIMENSIONS

CTSXY40-C

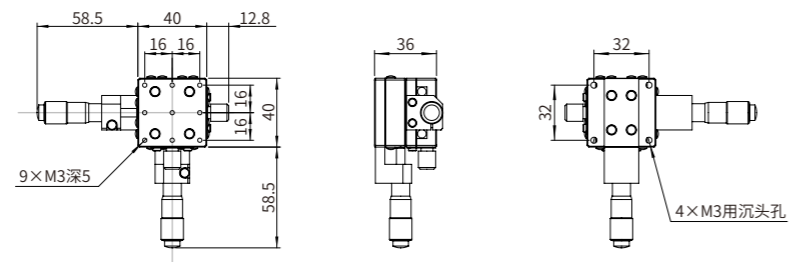
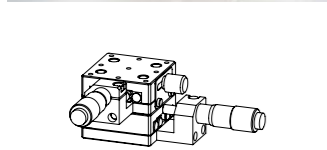

产品图纸 DIMENSIONS

CTSXY40-CB

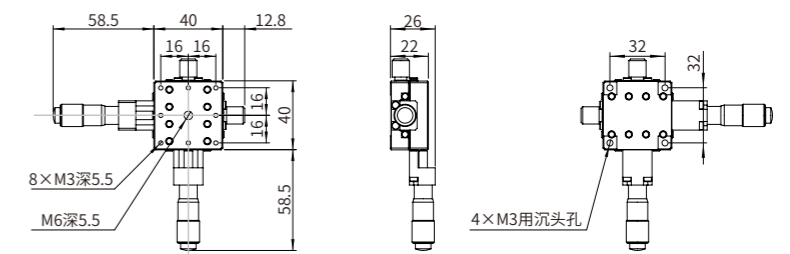
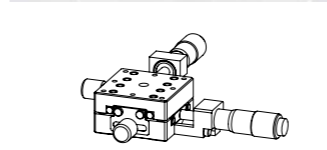

CTSXY40-L

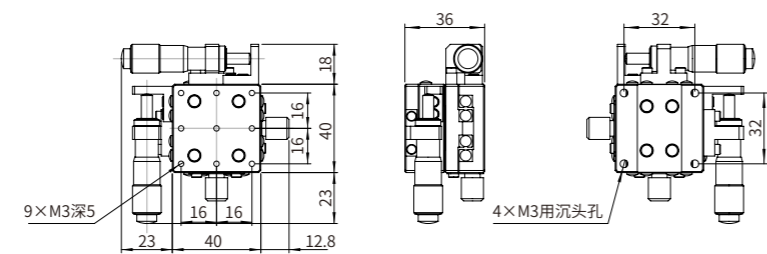
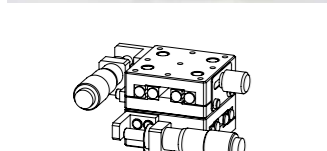

CTSXY40-LB

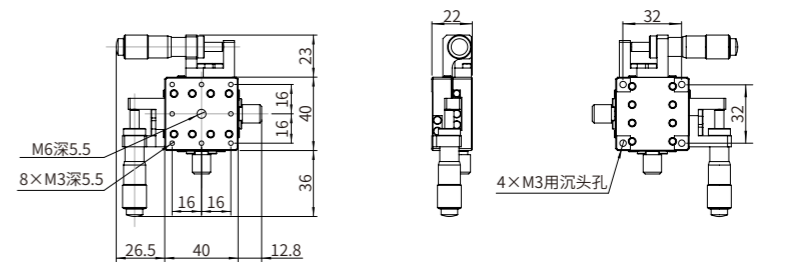
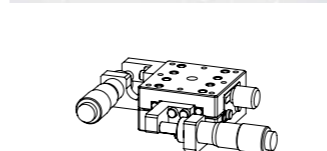

CTSXY40-R

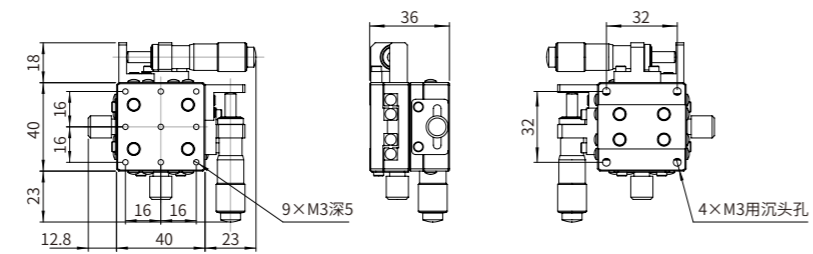
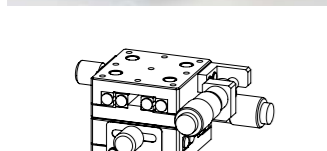

CTSXY40-RB

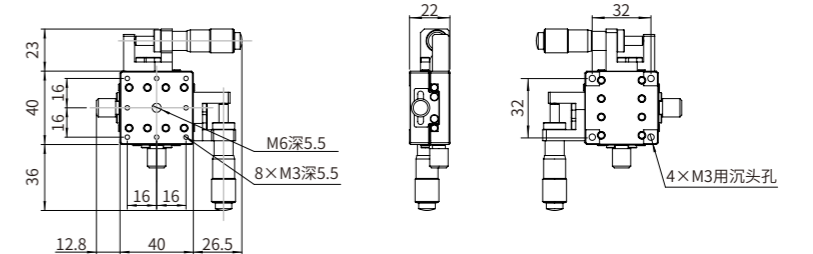
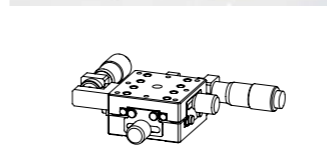

CTS40系列  
交叉滚柱导轨手动位移台

CTS40 Cross-Roller Guide Manual Stages

CTS40-(X) CTSXY40-(X)  
CTSXY40-(X)B CTSXYZ40-(X)



产品图纸 DIMENSIONS

CTSXYZ40-C

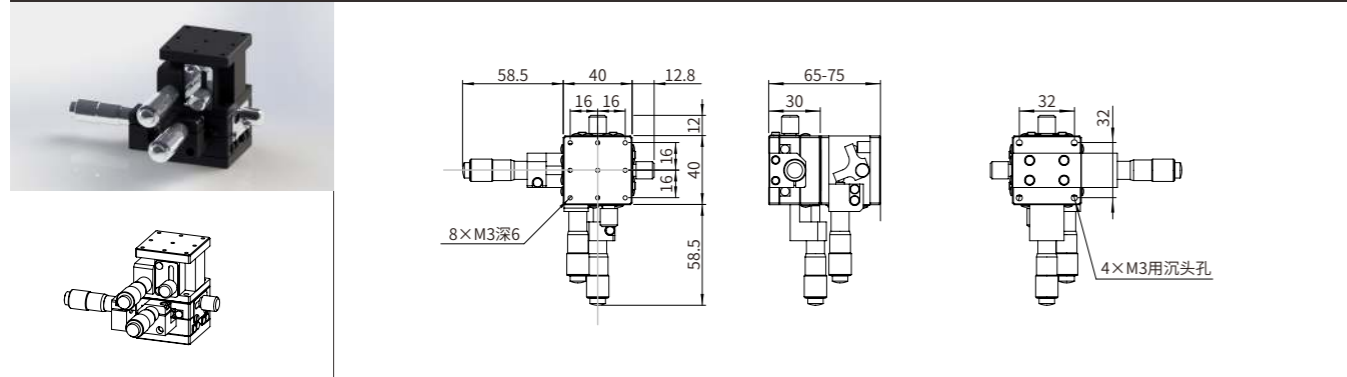

CTSXYZ40-L

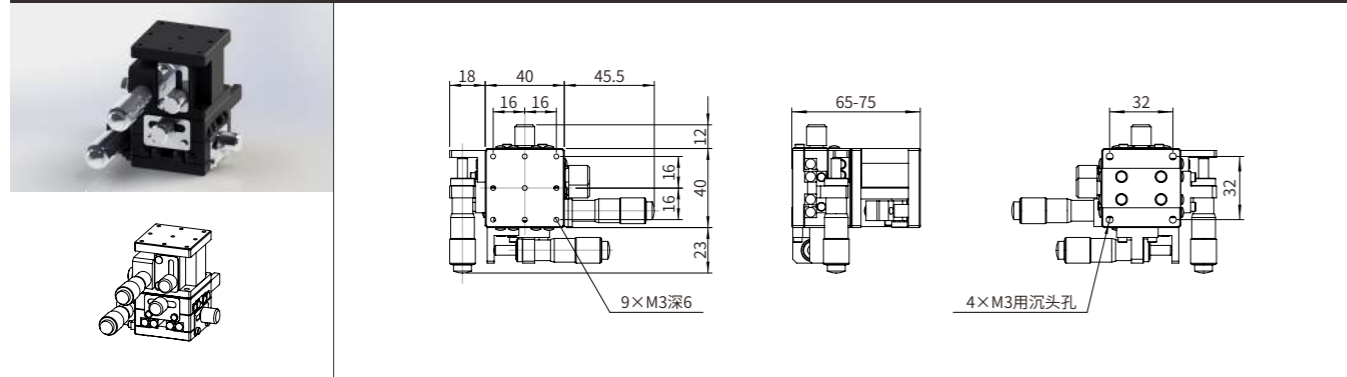

CTSXYZ40-R

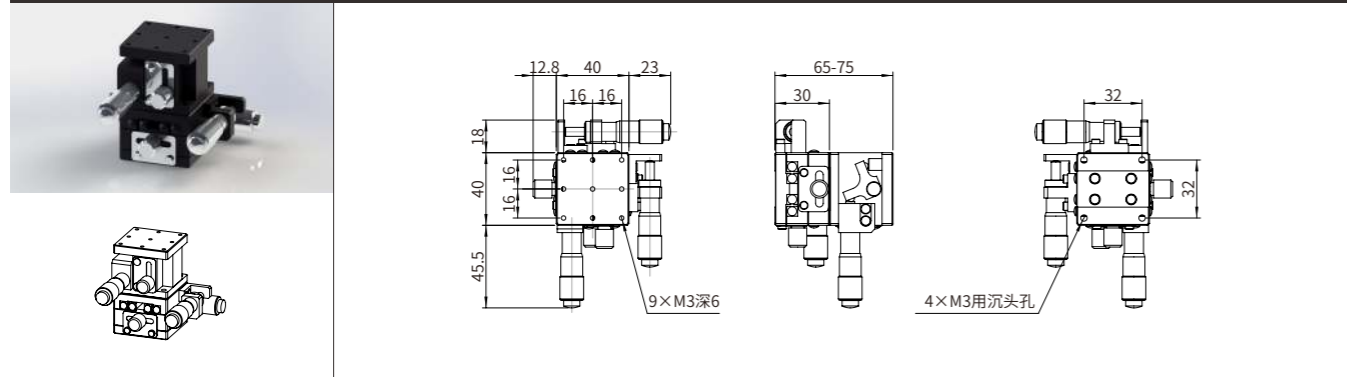

产品参数 SPECIFICATIONS

| Model       | CTS40-(X)                | CTSXY40-(X) | CTSXY40-(X)B | CTSXYZ40-(X) |
|-------------|--------------------------|-------------|--------------|--------------|
| 行程(mm)      | ±6.5                     |             |              | XY:±6.5;Z:10 |
| 水平负载(kg)    | 3                        | 3           | 1            | 2            |
| 位移方向        | X轴                       | XY轴         |              | XYZ轴         |
| 灵敏度(μm)     | 2                        |             |              |              |
| 平行度(μm)     | 5                        |             |              |              |
| 直线度(μm)     | 3                        |             |              |              |
| 微分头最小读数(mm) | 0.01                     |             |              |              |
| 导轨          | 交叉滚柱导轨                   |             |              |              |
| 驱动方式        | 微分头                      |             |              |              |
| 驱动位置        | X- C:中心驱动;L:左侧驱动; R:右侧驱动 |             |              |              |
| 主体材料及表面处理   | 铝合金, 阳极氧化                |             |              |              |
| 台面尺寸(mm)    | 40X40                    |             |              |              |
| 厚度(mm)      | 18                       | 36          | 22           | 65-75        |
| 自重(kg)      | 0.14                     | 0.28        | 0.21         | 0.44         |